

APD385V



POWER
YOUR
FUTURE

**385kVA / 308kW
POWERED by VOLVO**

DIESEL GENERATING SET 400/230 V - 50 Hz - 3 Phase

MODEL			APD385V
Power Pf. 0.8	Standby	kVA	385
		kW	308
	Prime	kVA	350
		kW	280

Standby: Continuous running at variable load for duration of an emergency. No overload is permitted on these ratings. In accordance with ISO 3046 .
Prime: Continuous running at variable load for unlimited periods with 10% overload available for 1 hour in any 12 hour period. In accordance with ISO 8528,ISO 3046.

- ✓ High quality, reliable and complete power unit
- ✓ Compact design
- ✓ Easy start and maintenance possibility
- ✓ Every generating set is subject to a comprehensive test program which includes full load testing, checking and provision of all control and safety shut down functions testing
- ✓ Fully engineered with a wide range of options and accessories: Canopy, sound proof canopy and off-road trailer



Manufacturer reserves the right to make changes in model, technical specifications, color, equipment and accessories without prior notice. Pictures for reference only.

ENGINE

VOLVO PENTA		
Model		TAD1342GE
Engine Power Output at rated rpm	kWm	343
	HP	466
Aspiration and Cooling		Turbocharged-Change Air Cooled
Total Displacement	Litre	12.78
No. of Cylinders and Build		6 Cylinder, In-Line
Engine Speed	rpm	1500
Bore and Stroke	mmxmm	131 × 158
Compression Ratio		18.1:1
Governor		Electronic control (Volvo / EMS 2.2)
Fuel Consumption at 100% load	L/hr	70.3
Fuel Tank Capacity	Litre	Open:700/Canopy:700
Oil Capacity	Litre	36
Coolant Capacity	Litre	44
Radiator Cooling Air	m ³ /min	402
Air Intake – Engine	m ³ /min	25.9
Exhaust Gas Flow	m ³ /min	57

- ✓ Heavy duty Volvo Penta diesel engine
- ✓ Four stroke, water cooled, turbocharged
- ✓ Direct injection fuel system
- ✓ Electronic Governor system
- ✓ 24 V D.C. starter and charge alternator
- ✓ Replaceable fuel filter, oil filter and dry element air filter
- ✓ Cooling radiator and fan
- ✓ Starter battery (with lead acid) including Rack and Cables
- ✓ Flexible fuel connection hoses and manual oil sump drain valve
- ✓ Industrial capacity exhaust silencer and steel bellows
- ✓ Operation manuals and circuit diagram documents

ALTERNATOR

Design	Brushless single bearing, revolving field
Stator	2/3 pitch
Rotor	Single bearing, flexible disc
Insulation System	Class H
Standard Temperature Rise	125 - 163°C Continuous
Exciter Type	Self Excited
Phase Rotation	A (U), B (V), C (W)
Alternator Cooling	Direct drive centrifugal blower fan
AC Waveform Total Harmonic Distortion	No load < 1.5%. Non distorting balanced linear load < 5%
Telephone Influence Factor (TIF)	<50 per NEMA MG1-22.43
Telephone Harmonic Factor (THF)	<2%

- ✓ Brushless, single bearing system, flexible disc, 4 poles
- ✓ Insulation class H
- ✓ Standard degree of protection IP23
- ✓ Self-exciting and self-regulating
- ✓ All wound components are impregnated with materials and processes designed specifically
- ✓ Solid state Automatic Voltage Regulator
- ✓ Stator winding with 2/3 pitch for improved harmonics

CONTROL SYSTEM

Control supervision and protection panel is mounted on the genset base frame. The control panel is equipped as follows:

1. Auto Mains Failure Control Panel

Panel equipments:

- ✓ Control with AMF module
- ✓ Static battery charger
- ✓ Emergency stop push button

a) Generating set control module DSE 7320 features:

- ✓ The module is used to monitor a mains supply and starts and stops a standby generating set
- ✓ Micro-processor based design
- ✓ Automatic control of mains and generator contactors
- ✓ Monitors engine performance and AC power output
- ✓ LED alarm indication
- ✓ Front panel configuration of timers and alarm trip points
- ✓ Easy push button control
STOP/RESET - MANUAL - TEST- AUTO - MUTE ALARM - START

b) Metering via LED display:

- ✓ Generator Volts (L-L / L-N)
- ✓ Engine oil pressure (PSI-Bar)
- ✓ Generator Ampere (L1,L2,L3)
- ✓ Engine temperature (° C & ° F)
- ✓ Generator Frequency (Hz)
- ✓ Plant battery volts
- ✓ Engine hours run
- ✓ Mains Volts (Ph-Ph/Ph-N)
- ✓ Generator kVA, kWh
- ✓ Generator kW as % of rated kW setting
- ✓ Generator Cos (σ)

2. Power Outlet Terminal Board Mounted on the Genset Base Frame



DSE 7320

c) Alarms:

- ✓ Over and Under Speed
- ✓ Low and High Battery Volt.
- ✓ Start and Stop Failure
- ✓ Charge fail
- ✓ Over Current
- ✓ Under / Over Generator Voltage
- ✓ Low Oil Pressure
- ✓ Emergency stop
- ✓ High engine temperature
- ✓ kW overload
- ✓ Unbalanced load
- ✓ Independent earth fault trip

d) LED indications

Four configurable LED's like:

- ✓ Mains available
- ✓ Generator available
- ✓ Mains on load
- ✓ Generator on load

OPTIONAL EQUIPMENTS

Diesel Engine

- ✓ Oil heater

Alternator

- ✓ 3/4 Pole Output Circuit Breaker
- ✓ Anti-condensation Heater

Panel

- ✓ Charge ammeter
- ✓ Transfer Switch 3 Pole
- ✓ Transfer Switch 4 Pole
- ✓ Earth Fault ,single set

Accessories

- ✓ Bulk fuel tank
- ✓ Automatic filling system
- ✓ Fuel-water separator filter
- ✓ Low fuel level alarm
- ✓ Residential silencer
- ✓ Enclosure or sound proof canopy
- ✓ Trailer
- ✓ Manual oil drain pump
- ✓ Tool kit for maintenance

CHASSIS

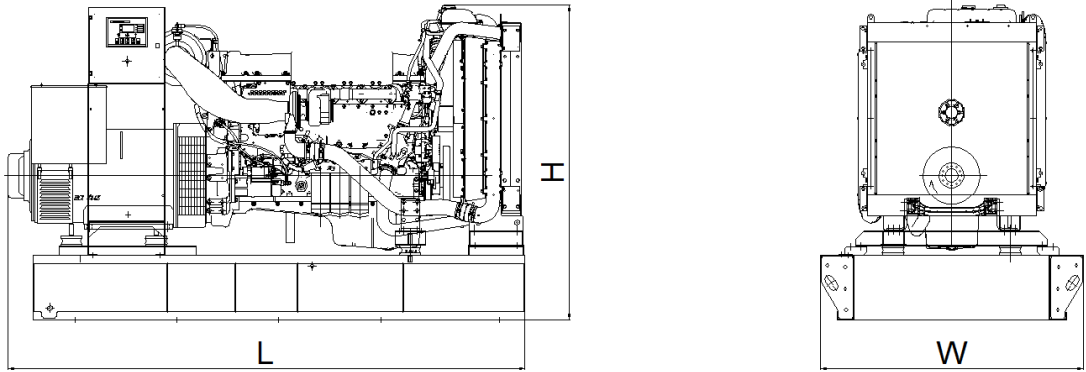

- ✓ The complete gen-set is mounted as whole on a heavy-duty fabricated, steel base frame
- ✓ Anti-vibration pads are fixed between the engine/ alternator feet and the base frame
- ✓ Base frame design incorporates an integral fuel tank (Up to 750 kVA)
- ✓ The generating set can be lifted or carefully pushed / pulled by the base frame
- ✓ Dial type fuel gauge and drain plug on the fuel tank

DIMENSIONS

OPEN TYPE

DIMENSIONS (LxWxH)	mm	2974*1550*1985
DRY WEIGHT	kg	3104

SOUND ATTENUATED TYPE

DIMENSIONS (LxWxH)	mm	4463*1606*2559
DRY WEIGHT	kg	4010

CANOPY

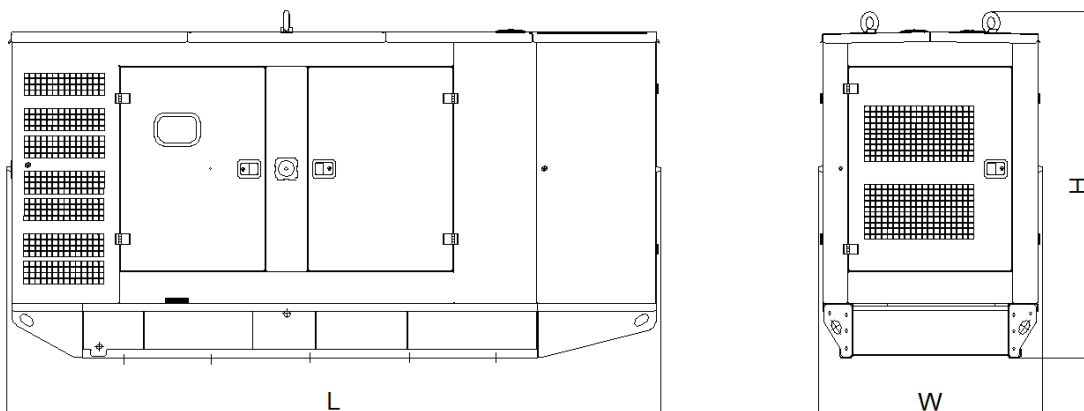

- ✓ All canopy parts are designed with modular principles
- ✓ Without welding assembly
- ✓ Doors on each side
- ✓ All metal canopy parts are painted by electrostatic polyester powder paint
- ✓ Exhaust silencer is protected against environment influences
- ✓ Thermally insulated engine exhaust system
- ✓ Emergency stop push button is installed outside of the canopy
- ✓ Easy lifting and moving
- ✓ Easy maintenance and operation

Aksa Power Generation

Ruzgarlibahce Mahallesi - Özalp Cikmazi No:10 34805 Kavacik Beykoz - Istanbul / Turkey

Tel:+90 212 444 46 30 E-mail: aksa@aksapowergen.com

www.aksapowergen.com

Aksa Power Generation is a member of  KAZANCI HOLDING www.aksa.com.tr